

Sliding Windows





















Region B:

N2	Wind Classification
400Pa	Serviceability
1000Pa	Ultimate Strength
150Pa	Water Penetration

STANDARD SIZES

Availability of standard sizes subject to wind load and water penetration requirements

Region C: Design wind pressure is calculated to 'AS/NZS 1170.2 Structural design actions – Wind action'

STUD	OPENING	FRAME SIZE								
		610mm	910mm	1210mm	1510mm	1810mm	2110mm	2410mm	2710mm	3010mm
650mm	600mm									
		SF0606	SF0609	SF0612	SF0615	SF0618	SF0621	SFS0624	SFS0627	SFS0630
950mm	900mm									
		SF0906	SF0909	SF0912	SF0915	SF0918	SF0921	SFS0924	SFS0927	SFS0930
1050mm	1000mm									
		SF1006	SF1009	SF1012	SF1015	SF1018	SF1021	SFS1024	SFS1027	SFS1030
1250mm	1200mm									
		SF1209	SF1212	SF1215	SF1218	SF1221	SFS1224	SFS1227	SFS1230	
1550mm	1500mm									
		SF1512	SF1515	SF1518	SF1521	SFS1524	SFS1527	SFS1530		
1850mm	1800mm									
		SF/F1809	SF/F1812	SF/FF1815	SF/FF1818	SF/FF1821	SFS/FFF1824	SFS/FFF1827	SFS/FFF1830	
2150mm	2100mm									
		SF/F2112	SF/FF2115	SF/FF2118	SF/FF2121	SFS/FFF2124	SFS/FFF2127	SFS/FFF2130		

- Also available in FS or FSSF configurations
- FSSF configuration is available in sizes 1810mm in width and larger

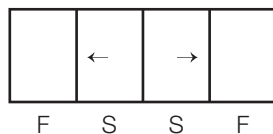
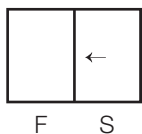

S = Sliding Panel
F = Fixed Panel (Viewed from exterior)

Note: Sliding Windows may be subject to local variation or regulatory requirements

Double Hung Windows

Region B:

N2	Wind Classification
400Pa	Serviceability
1000Pa	Ultimate Strength
150Pa	Water Penetration

STANDARD SIZES

Availability of standard sizes subject to wind load and water penetration requirements

Region C: Design wind pressure is calculated to 'AS/NZS 1170.2 Structural design actions – Wind action'

STUD	OPENING	660mm	960mm	1260mm	1560mm	1860mm	2160mm	2460mm	2760mm	3060mm
	FRAME SIZE	610mm	910mm	1210mm	1510mm	1810mm	2110mm	2410mm	2710mm	3010mm
950mm	900mm	 D0906	 D0909	 D0912	 DD0915	 DD0918	 DDD0921	 DDD0924	 DDD0927	 DDD0930
1050mm	1000mm	 D1006	 D1009	 D1012	 DD1015	 DD1018	 DDD1021	 DDD1024	 DDD1027	 DDD1030
1250mm	1200mm	 D1206	 D1209	 D1212	 DD1215	 DD1218	 DDD1221	 DDD1224	 DDD1227	 DDD1230
1550mm	1500mm	 D1506	 D1509	 DD1512	 DD1515	 DD1518	 DDD1521	 DDD1524	 DDD1527	 DDD1530
1850mm	1800mm	 D1806	 D1809	 DD1812	 DD1815	 DD1818	 DDD1821	 DDD1824	 DDD1827	
2150mm	2100mm	 D2106	 D2109	 DD2112	 DD2115	 DD2118	 DDD2121	 DDD2124	 DDD2127	

Note: Double Hung Windows may be subject to local variation or regulatory requirements

Awning Windows































































Region B:

N2	Wind Classification
400Pa	Serviceability
1000Pa	Ultimate Strength
150Pa	Water Penetration

STANDARD SIZES

Availability of standard sizes subject to wind load and water penetration requirements

Region C: Design wind pressure is calculated to 'AS/NZS 1170.2 Structural design actions – Wind action'

STUD	OPENING	660mm	960mm	1260mm	1560mm	1860mm	2160mm	2460mm	2760mm	3060mm
	FRAME SIZE	610mm	910mm	1210mm	1510mm	1810mm	2110mm	2410mm	2710mm	3010mm
650mm	600mm									
		A0606	A0609	AA0612	AA0615	AA0618	AAA0621	AAA0624	AAA0627	AAA0630
950mm	900mm									
		A0906	A0909	AA0912	AA0915	AA0918	AAA0921	AAA0924	AAA0927	AAA0930
1050mm	1000mm									
		A1006	A1009	AA1012	AA1015	AA1018	AAA1021	AAA1024	AAA1027	AAA1030
1250mm	1200mm									
		A1206	A1209	AA1212	AA1215	AA1218	AAA1221	AAA1224	AAA1227	AAA1230
1550mm	1500mm									
		A1506	A1509	AA1512	AA1515	AA1518	AAA1521	AAA1524	AAA1527	AAA1530
1850mm	1200mm									
	600mm	A/F1806	A/F1809	AA/F1812	AA/FF1815	AA/FF1818	AAA/FFF1821	AAA/FFF1824	AAA/FFF1827	AAA/FFF1830
2150mm	1500mm									
	600mm	A/F2106	A/F2109	AA/F2112	AA/FF2115	AA/FF2118	AAA/FFF2121	AAA/FFF2124	AAA/FFF2127	AAA/FFF2130

Note: Awning Windows may be subject to local variation or regulatory requirements

Casement Windows

Region B:

N2	Wind Classification
400Pa	Serviceability
1000Pa	Ultimate Strength
150Pa	Water Penetration

STANDARD SIZES

Availability of standard sizes subject to wind load and water penetration requirements

Region C: Design wind pressure is calculated to 'AS/NZS 1170.2 Structural design actions – Wind action'

STUD	OPENING	660mm	960mm	1260mm	1560mm	1860mm	2160mm	2460mm
	FRAME SIZE	610mm	910mm	1210mm	1510mm	1810mm	2110mm	2410mm
650mm	600mm	C0606	CC0609	CC0612	CCC0615	CCC0618	CCCC0621	CCCC0624
950mm	900mm	C0906	CC0909	CC0912	CCC0915	CCC0918	CCCC0921	CCCC0924
1050mm	1000mm	C1006	CC1009	CC1012	CCC1015	CCC1018	CCCC1021	CCCC1024
1250mm	1200mm	C1206	CC1209	CC1212	CCC1215	CCC1218	CCCC1221	CCCC1224
1550mm	1500mm	C1506	CC1509	CC1512	CCC1515	CCC1518	CCCC1521	CCCC1524

Note: Maximum sash width 600mm

Note: Casement Windows may be subject to local variation or regulatory requirements

Louvre Windows

STANDARD SIZES

The availability of certain sizes and configurations is dependent on the design wind load requirement as per AS2047-2014. Check with your Bradnam's representative to confirm availability.

Louvre Information

- Using standard galleries (No extension pieces)
- Black hardware standard
- L = Single Louvre Bay

152mm Blades Stud Opening (mm)	152mm Blades Frame Height (mm)	102mm Blades Stud Opening (mm)	102mm Blades Frame Height (mm)	Number of Blades
412	362	N/A	N/A	2
552	502	N/A	N/A	3
691	641	488	438	4
831	781	577	527	5
971	921	666	616	6
1110	1060	755	705	7
1250	1200	844	794	8
1390	1340	933	883	9
1529	1479	1021	971	10
1669	1619	1110	1060	11
1809	1759	1199	1149	12
1949	1899	1288	1238	13
2088	2038	1377	1327	14
2228	2178	1466	1416	15
2368	2318	1555	1505	16
2507	2457	1644	1594	17
2647	2597	1733	1683	18
N/A	N/A	1822	1772	19
N/A	N/A	1910	1860	20
N/A	N/A	1999	1949	21
N/A	N/A	2088	2038	22
N/A	N/A	2177	2127	23
N/A	N/A	2266	2216	24
N/A	N/A	2355	2305	25
N/A	N/A	2444	2394	26
N/A	N/A	2533	2483	27
N/A	N/A	2622	2572	28
N/A	N/A	2711	2661	29

Frame Widths (mm)

L	610
L	910
LL	1210
LL	1510
LL	1810
LLL	2110
LLL	2410
LLL	2710

Note

- Blades can be glass, timber or aluminium
- Handle on LH side viewed from inside as standard

Note: Louvre Windows may be subject to local variation or regulatory requirements

Sliding Doors









Region B:

N2	Wind Classification
400Pa	Serviceability
1000Pa	Ultimate Strength
150Pa	Water Penetration

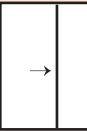
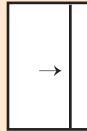

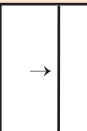

STANDARD SIZES

Availability of standard sizes subject to wind load and water penetration requirements

Region C: Design wind pressure is calculated to 'AS/NZS 1170.2 Structural design actions – Wind action'

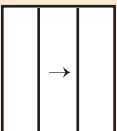
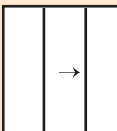
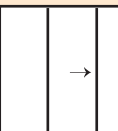
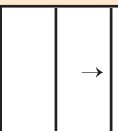
		OPENING	1560mm	1860mm	2160mm	2460mm	2760mm	
		STUD	FRAME SIZE	1510mm	1810mm	2110mm	2410mm	2710mm
2130mm	2100mm							
			SF2115	SF2118	SF2121	SF2124	SF2127	
2430mm	2400mm							
			SF2415	SF2418	SF2421	SF2424	SF2427	

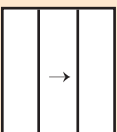
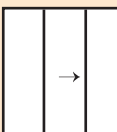
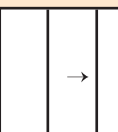
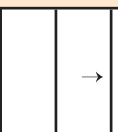
Also available in FS configuration

		OPENING	2288mm	2738mm	3188mm	3638mm	4058mm	
		STUD	FRAME SIZE	2238mm	2688mm	3138mm	3588mm	4038mm
2130mm	2100mm							
			FFS2122	FFS2127	FFS2131	FFS2136	FFS2140	
2430mm	2400mm							
			FFS2422	FFS2427	FFS2431	FFS2436	FFS2440	

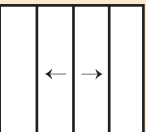
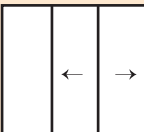
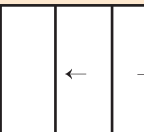
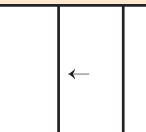
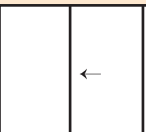
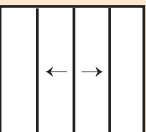
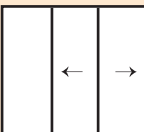
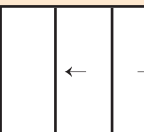
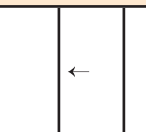
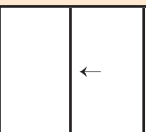
		OPENING	3034mm	3634mm	4234mm	4834mm	5434mm	
		STUD	FRAME SIZE	2984mm	3584mm	4184mm	4784mm	5384mm
2130mm	2100mm							
			FSSF2130	FSSF2136	FSSF2142	FSSF2148	FSSF2154	
2430mm	2400mm							
			FSSF2430	FSSF2436	FSSF2442	FSSF2448	FSSF2454	

S = Sliding Panel
F = Fixed Panel (Viewed from exterior)

Note: Sliding Doors may be subject to local variation or regulatory requirements

Stacker Doors

Region B:

N2	Wind Classification
400Pa	Serviceability
1000Pa	Ultimate Strength
150Pa	Water Penetration

STANDARD SIZES

Availability of standard sizes subject to wind load and water penetration requirements

Region C: Design wind pressure is calculated to 'AS/NZS 1170.2 Structural design actions – Wind action'

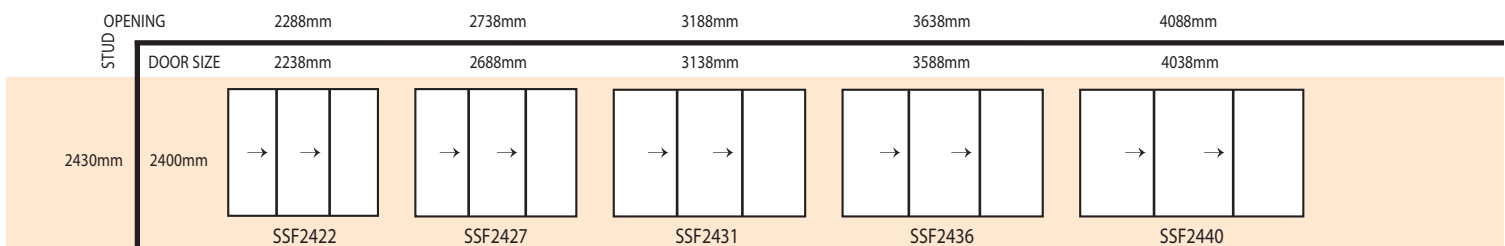
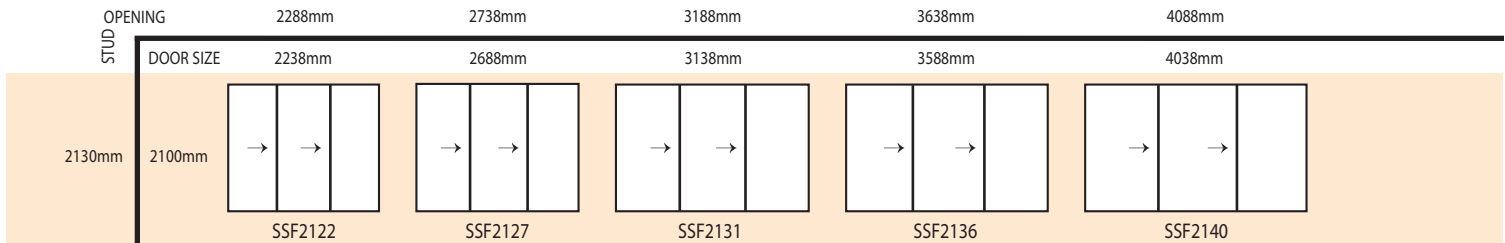

Also available in FSS configuration

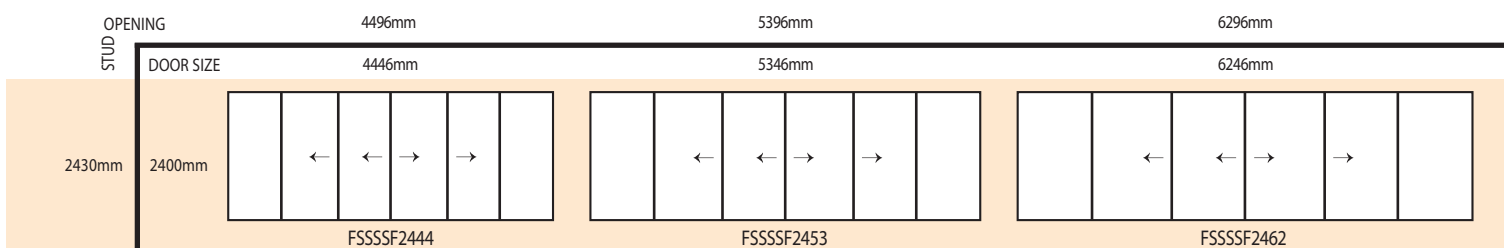
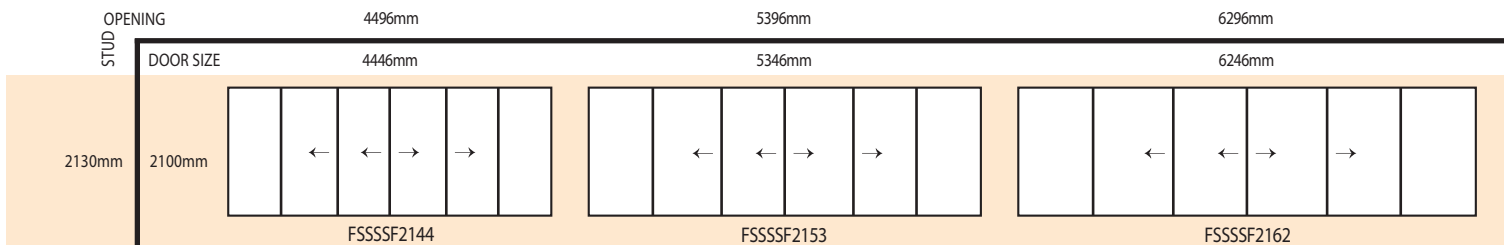

Non Standard Configurations Available

- Availability subject to local variations or climate requirements.
- Screening not available in these non standard configurations.

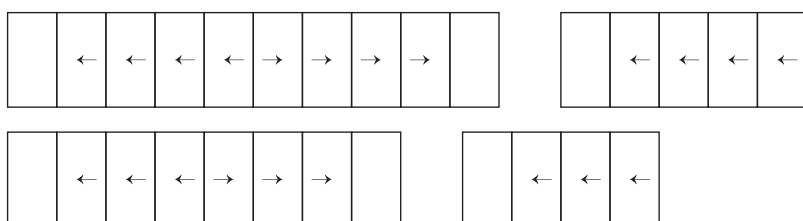

S = Sliding Panel
F = Fixed Panel (Viewed from exterior)

Note: Stacker Doors may be subject to local variation or regulatory requirements

Bi-fold Doors

Region B:

N2	Wind Classification
400Pa	Serviceability
1000Pa	Ultimate Strength
150Pa	Water Penetration

SIZES

Availability of sizes subject to wind load and water penetration requirements

Region C: Design wind pressure is calculated to 'AS/NZS 1170.2 Structural design actions – Wind action'

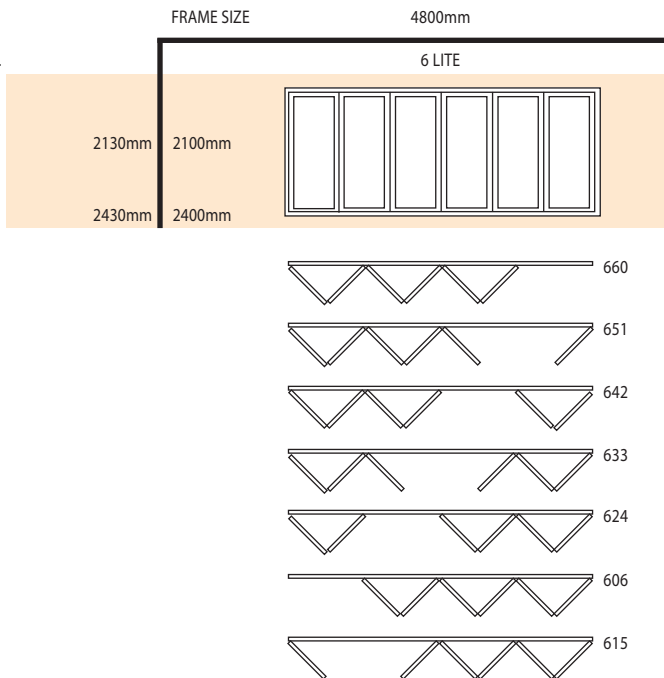
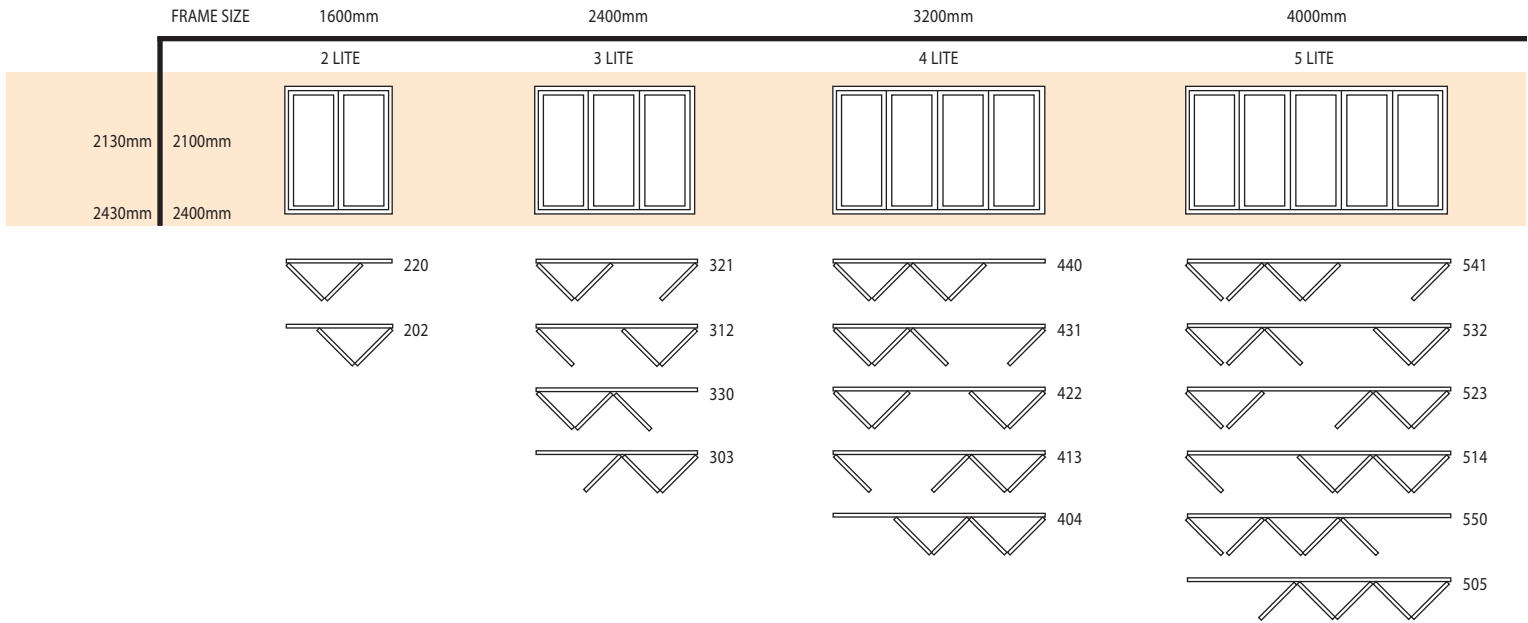

Bi-Fold Numbering

eg: **321** (View from left to right)

3	2	1
Total panels	No of panels opening to left	No of panels opening to right

Note: Bi-fold Doors may be subject to local variation or regulatory requirements

Hinged Doors

STANDARD SIZES

Region B:

N2	Wind Classification
400Pa	Serviceability
1000Pa	Ultimate Strength
150Pa	Water Penetration

Availability of standard sizes subject to wind load and water penetration requirements

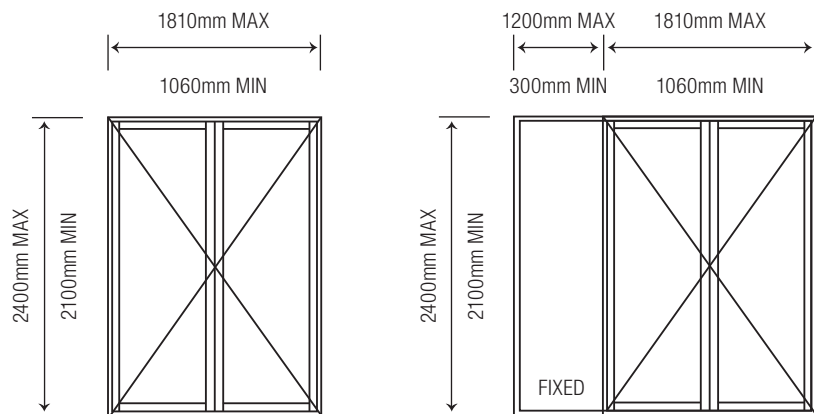

Region C: Design wind pressure is calculated to 'AS/NZS 1170.2 Structural design actions – Wind action'

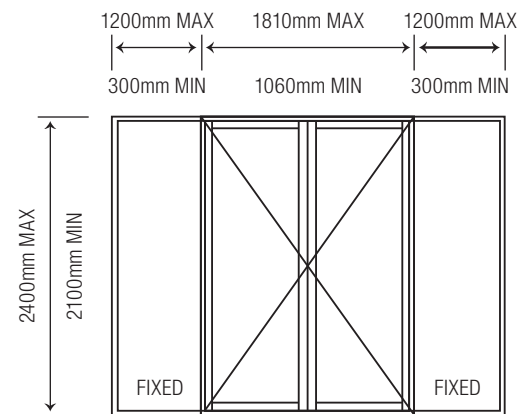

Hinged Door Information

- Available in 100mm or 125mm frame (please check availability)
- Single door options available upon application
- All doors to be supplied with sills
- Hi lites are available subject to confirmation of structural performance
- Operating sashes are available as Side Lites if required
- Maximum leaf size 870mm

Note: Hinged Doors may be subject to local variation or regulatory requirements